

**INSTRUCTION MANUAL FOR THE
PERFORMANCE MONITOR 2 (PM2)**

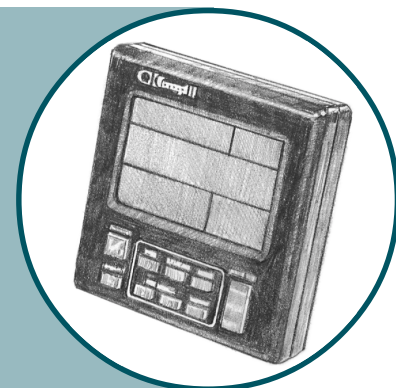

**INSTALLING AND USING
THE PM2 HEART RATE INTERFACE**

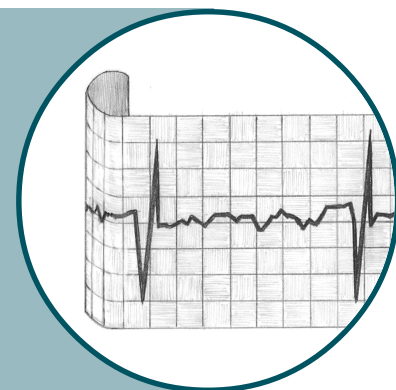

OVERVIEW OF PM2 OPERATION

Your Concept2 Indoor Rower is equipped with a PM2, the second generation of our electronic Performance Monitor. We have designed the PM2 to be as friendly as possible while making several powerful functions available to you.

There are three levels of operation:

- LEVEL I Automatic operation:** Like the original PM, the PM2 has an automatic mode which will monitor your workout without requiring you to use any buttons at all. You will also find it very easy to use the DISPLAY button to change the output units displayed. (See page 2)
- LEVEL II Preset Workouts and Recall:** To introduce more variety into your exercise program, you can set up four different kinds of workouts on the PM2: preset time duration, preset distance, timed intervals, and distance intervals. After you have finished a workout, you can use RECALL to view your performance. All Level II functions have labeled buttons. (See page 3)
- LEVEL III Extra Functions:** Advanced users can take advantage of these extra functions: two odometers (resettable and non-resettable), splits to be measured and displayed during your workout at an interval of your choice; drag factor display; and PM2 self-test. Extra functions are activated using button combinations which are described on page 6.



USING THE PERFORMANCE MONITOR (PM2)

LEVEL I. AUTOMATIC OPERATION

A. GETTING STARTED

All you need to do is get on and row. The PM2 will automatically come on and begin to display information about your performance. Here is what the displays are showing:

Your **ELAPSED TIME**: how long you have been rowing.

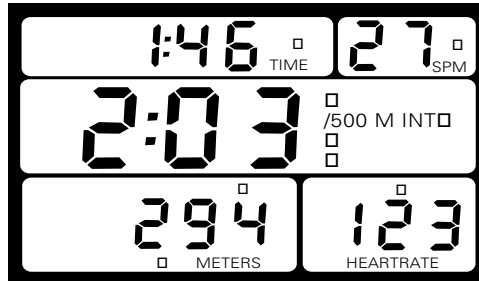

Your **STROKE RATE** or cadence in Strokes per Minute (**SPM**), updated every stroke. Aim for somewhere between 20 and 30 spm.

Your **OUTPUT FOR EACH STROKE**: how hard you pulled on the last stroke. This is displayed in a choice of three units:

PACE/500 METERS: how long it would take you to row 500 meters if you kept rowing at that same pace. The smaller the number, the faster you are going.

CALORIES/HOUR: the rate at which you were burning calories during the last stroke. It displays the approximate number of calories you would burn in an hour if you kept rowing at that pace. The larger the number, the faster you are going.

WATTS: the power you exerted during the last stroke, in watts. The larger the number, the faster you are going.

Your **TOTAL OR CUMULATIVE OUTPUT** since you started rowing. This is displayed in a choice of 4 units:

AVERAGE PACE: what your average pace per 500 meters has been since you started.

METERS: the number of meters you have rowed since you started.

CALORIES: the approximate number of calories you have burned since you started.

WATTS: your average power output in watts since you started.

If you have the **OPTIONAL HEART RATE** interface* attached and are wearing a chest belt, this display will show your heart rate in beats per minute. For Heart Rate Interface installation, see pages 7 and 8.

*For more information see pages 7 - 10. To order your Heart Rate Interface, call Concept2 toll free at 1.800.245.5676.

B. DISPLAY OPTIONS

Now try pressing the DISPLAY button. Each time you press it, the display changes, cycling through the choices shown at right.

- You can choose any of these displays to watch while you row.
- You can change the display any time during your workout.

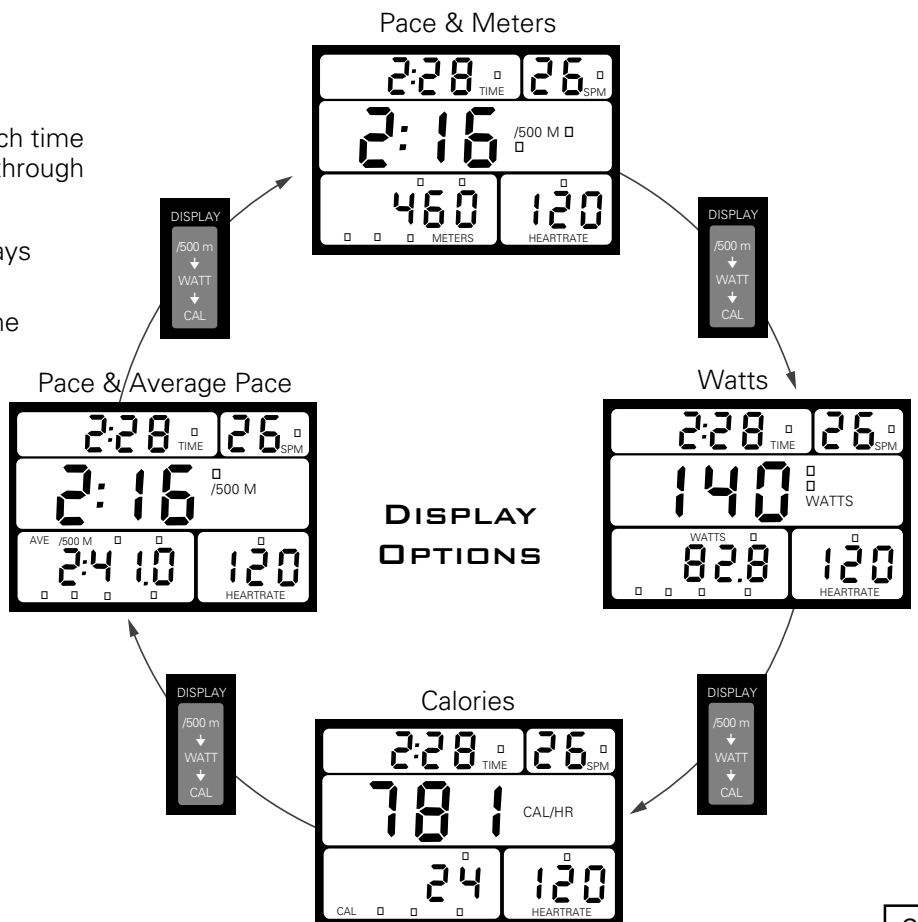

A WORD ABOUT CALORIES:

Due to the differences in body weight and efficiency, calories on the PM2 are only an approximation of calories burned by the person rowing. The formula used in the PM2 is as follows:

$$\text{Calories} = (4 \times \text{ave. watts} / 1.1639) + 300 \text{ cal/hour} \times \text{time rowed (in hours)}$$

This formula assumes a person of 175 pounds (80 kg.) and a base rate of 300 cal/hour to move your body through the rowing motion at 30 strokes/minute.

LEVEL II. PRESET WORKOUTS & RECALL

A. SETTING UP WORKOUTS

It is easy to set up a variety of workouts on your PM2. Specifically, you can set up:

- A single work session of preset time duration.
- A timed interval workout (alternating work time and rest time).
- A single work session of preset distance.
- A distance interval workout (alternating work distance and rest time).

All of these types of workouts can be set up using these buttons:

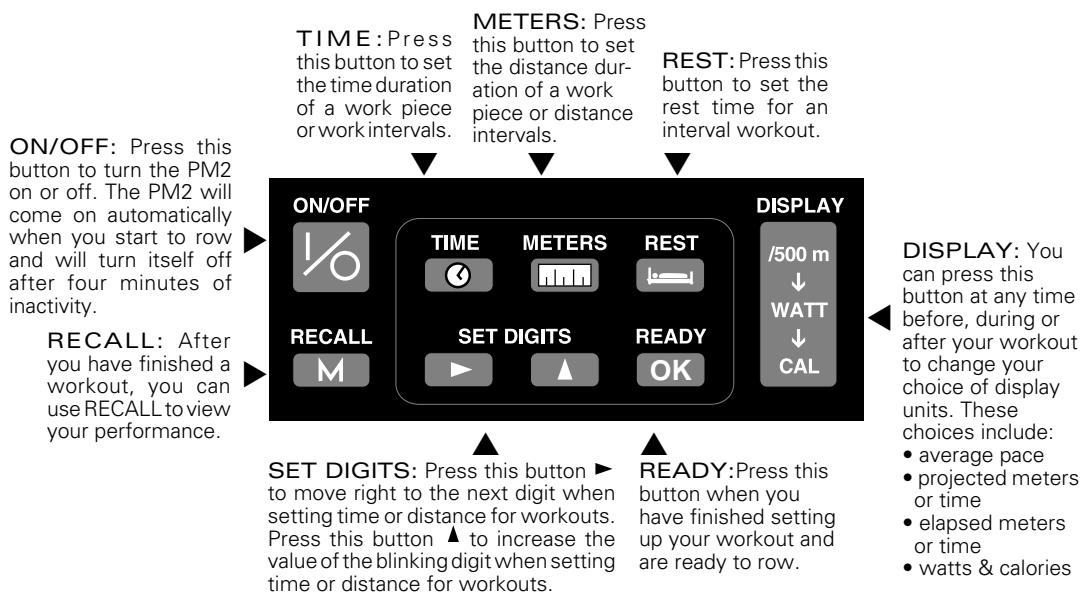

Projected Finish Display: When you are rowing one of these pre-set workouts, you will have an additional display option in the lower left field: Projected Finish Time or Distance. If you are rowing a preset distance, this display will show your projected finish time if you keep up your present pace. If you are rowing a preset time, this display will show your projected finish distance if you keep up your present pace. To see Projected Finish, simply press the DISPLAY button to cycle through the options until the word "PROJ" is displayed above the time or distance.

B. SAMPLE WORKOUTS:

The sample workouts on these two pages are designed to help you become familiar with this capability of your PM2. We encourage you to set them up on your own PM2 as you read through the instructions. They are also good workouts to try once you have learned proper rowing technique and built up your time rowing on the Indoor Rower.

Example #1:
PRESET TIME
45 minute row

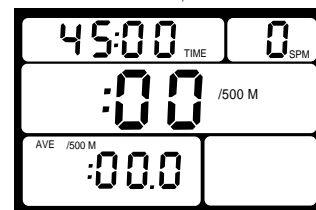
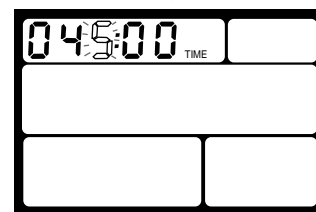
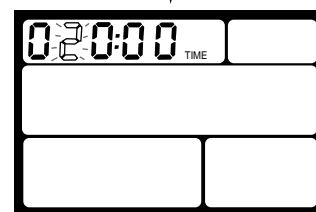
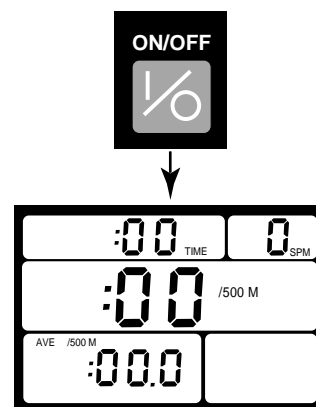

Example #2:
PRESET DISTANCE
5000 meter row

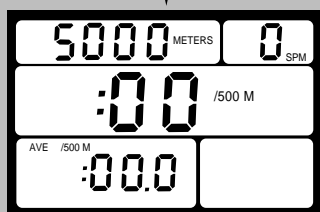
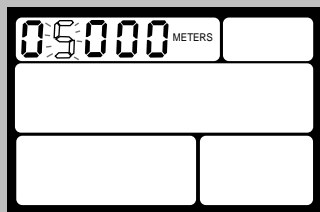
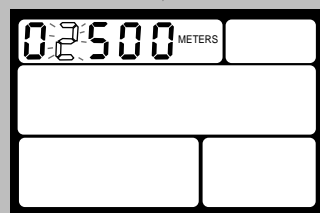
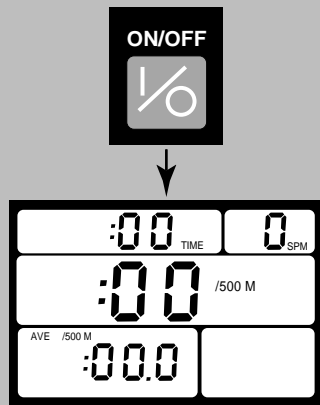

Example #3:
TIME INTERVALS
10 x 1 minute hard/
1 minute easy

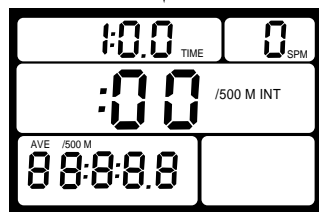
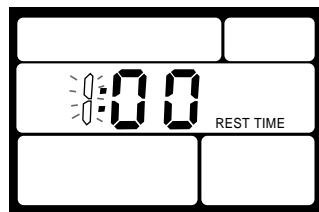
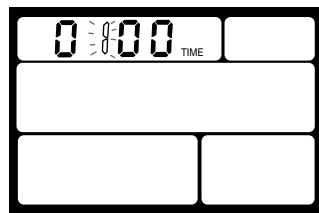
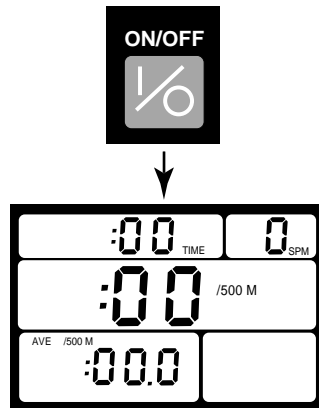

Example #4:
DISTANCE INTERVALS
5 x 500 meters
with 2 minutes rest

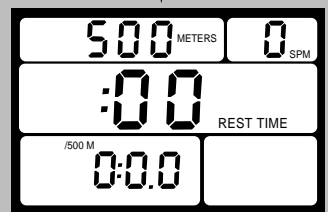
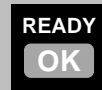
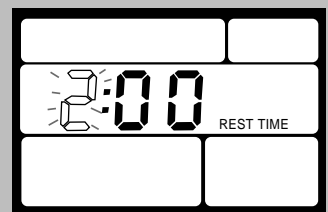
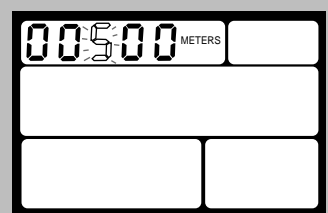
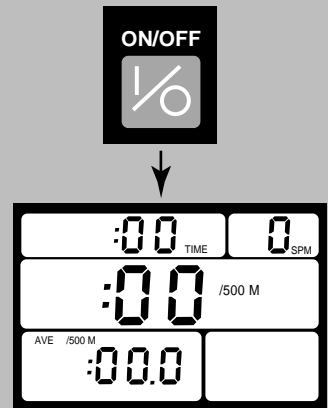

In examples 3 & 4:
The interval number will be displayed in the upper right corner during the rest interval.

You are now ready to row. You may change display now, during or after your workout.

C. USING RECALL

After you have finished a workout, you can use RECALL to view your performance during each split or interval of your workout.

The first press of the RECALL button displays the end of workout information for your workout. Each successive press of the RECALL button shows the next earlier split or interval until either the last split has been displayed or there is no more memory available (maximum storage is 20 splits or intervals). The word "SPLIT" will appear on the screen to indicate that you are viewing split information as opposed to end of workout information. Default splits are: two minutes for timed workouts and 500 meters for distance workouts. See next section to set custom splits.

NOTE: Your workout results will remain in the PM2 memory until another workout is started, even if the PM2 is turned off.

Tips:

- The ► button works the same as RECALL. It shows the next earlier split or interval.
- The ▲ button shows the next later split or interval.
- The DISPLAY button can be used during split recall to view splits in various units.
- Pressing REST during split recall shows splits in cumulative mode. This is indicated to the user by "CU" in the center display field. Press REST again to exit CU mode.
- HEART RATE box shows your heart rate at the end of that interval or split
- SPM box shows your average strokes per minute for the interval or split.

RECALL DISPLAY CHART

Type of Workout	Splits Taken	Recall Display
automatic count up mode	every two minutes (or custom split interval if set)	
preset timed workout	every two minutes (or custom split interval if set)	
preset distance workout	every 500 meters (or custom split interval if set)	
preset timed intervals	at end of each time interval	
preset distance intervals	at end of each distance interval	

LEVEL III. EXTRA FUNCTIONS (FOR ADVANCED USERS)

All of the PM2 buttons except the ON/OFF button have extra functions which are activated when you press and hold down the READY button. These special functions include:

- **Two Odometers:** one is resettable (trip odometer) and one is not resettable.
- **Split Intervals:** you can set the PM2 to measure splits at intervals which you set. Each split will be saved for recall after you finish and can be displayed for six seconds while you row.
- **Drag Factor:** you can set the PM2 to display the drag factor which it calculates during the rundown of the flywheel.
- **PM2 Display Test**

BUTTON SEQUENCES & DESCRIPTIONS OF EXTRA FUNCTIONS:

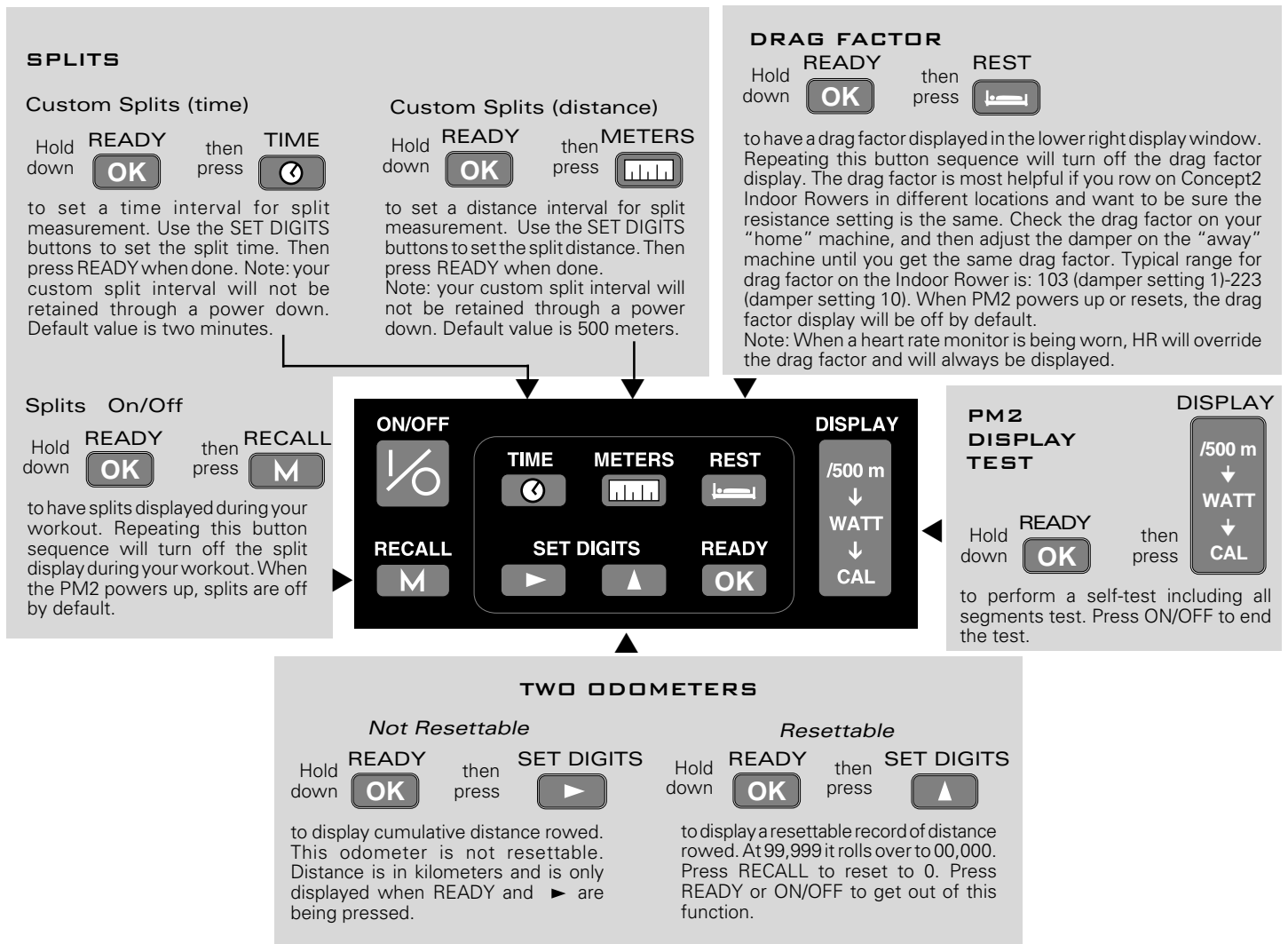

This equipment has been tested and found to comply with the limits for a Class B digital device, pursuant to Part 15 of the FCC rules. These limits are designed to provide reasonable protection against harmful interference in a residential installation. This equipment generates, uses and can radiate radio frequency energy and if not installed and used in accordance with the instructions, may cause harmful interference to radio communications. However, there is no guarantee that interference will not occur in a particular installation. If this equipment does cause harmful interference to radio or television reception, which can be determined by turning the equipment off and on, the user is encouraged to try to correct the interference by one or more of the following measures:

- Reorient or relocate the receiving antenna.
- Increase the separation between the equipment and the receiver.
- Connect the equipment into an outlet on a circuit different from that to which the receiver is connected.
- Consult the dealer or an experienced radio/TV technician for help.

THE OPTIONAL PM2 HEART RATE INTERFACE

Installing on Model B

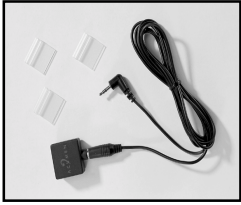

PN 1761



4.

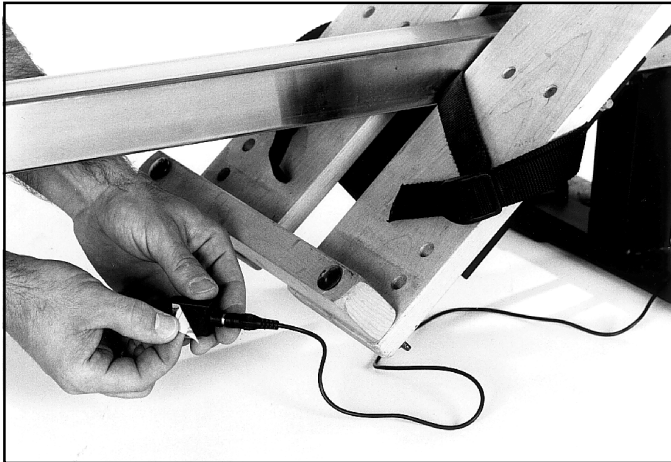

1.

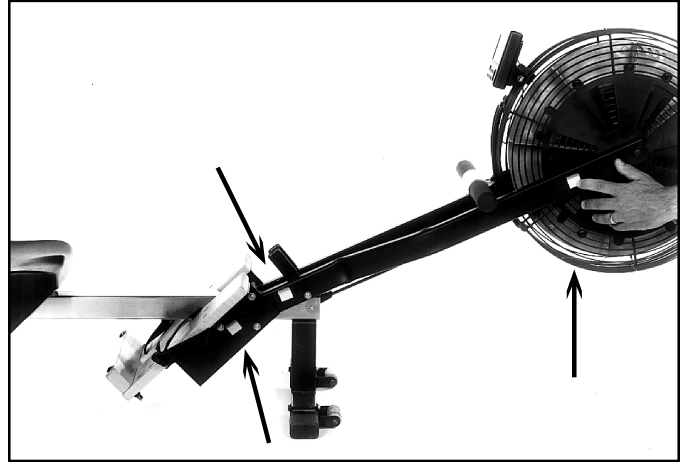

5.

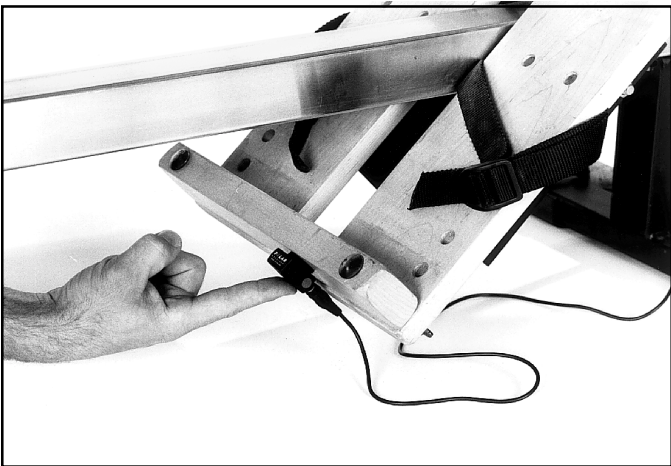

2.

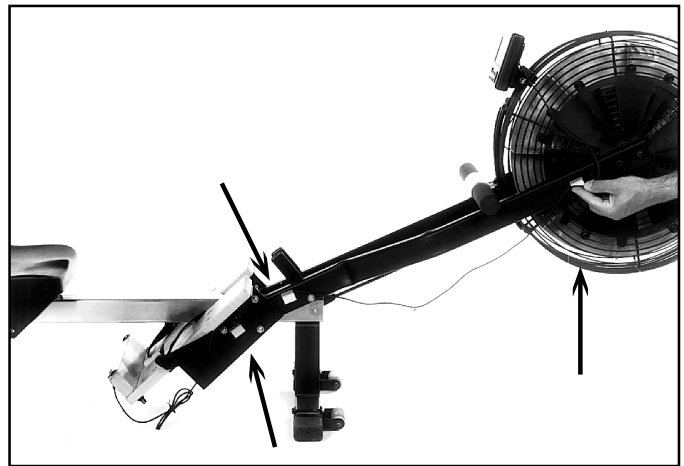

6.

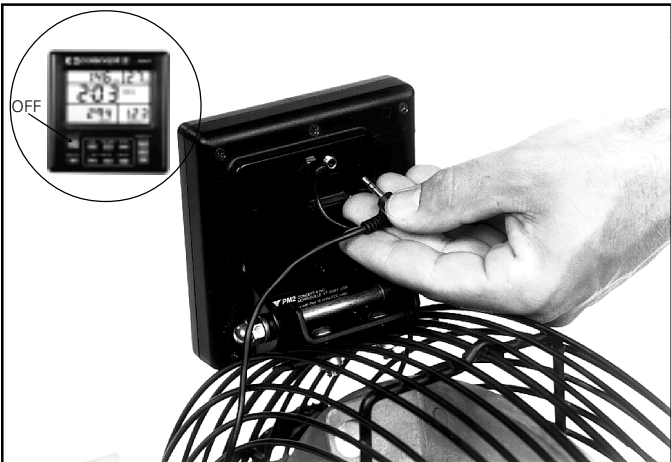

3.

If signal is not picked up, place the receiver on the floor under the middle of the monorail.

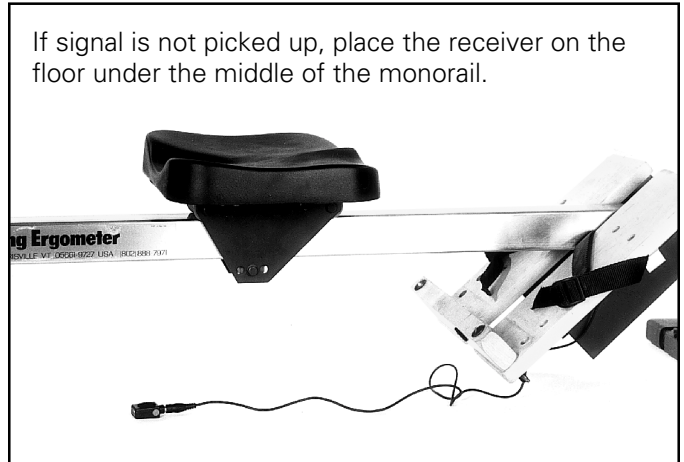

7.

THE OPTIONAL PM2 HEART RATE INTERFACE

Installing on Model C

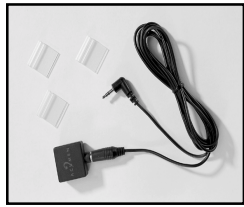

PN 1761

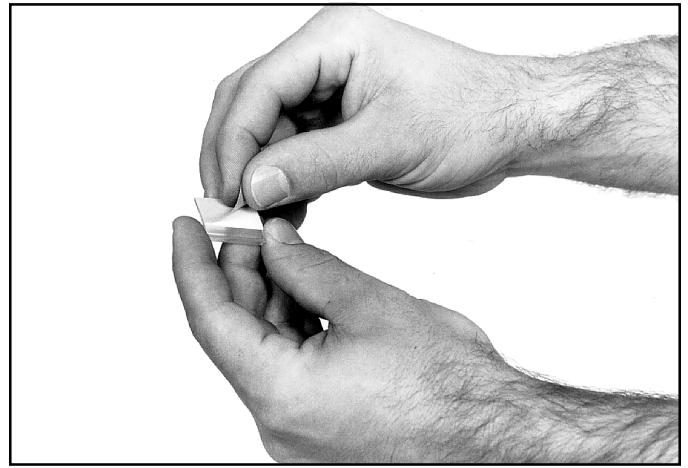

4.

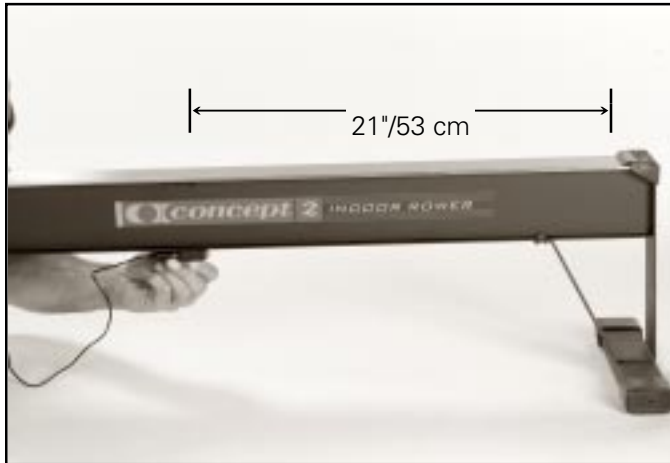

1.

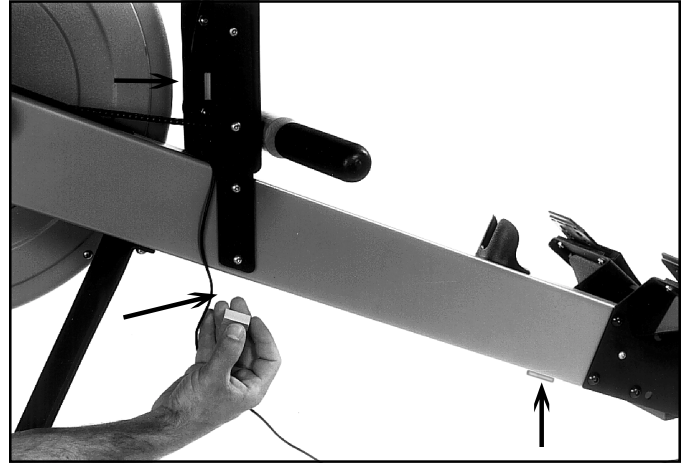

5.

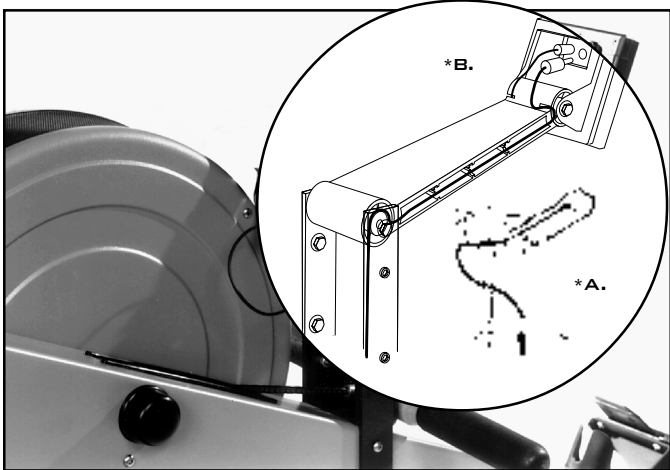

2.

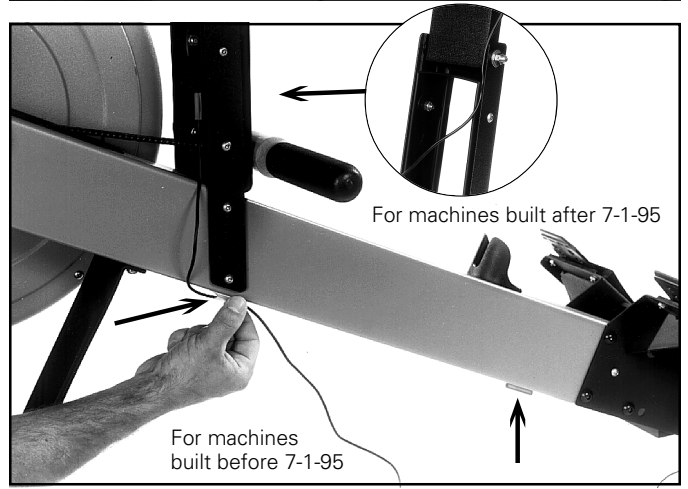

6.

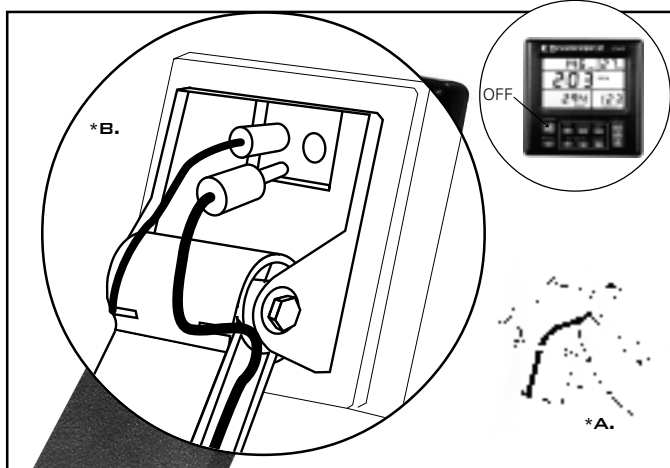

3.

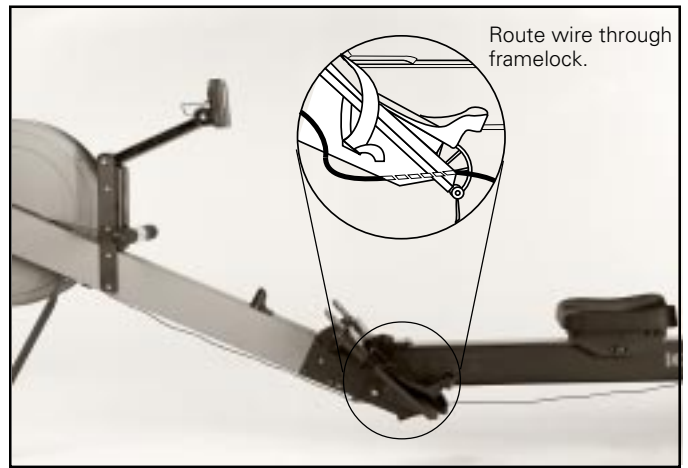

7.

*A. Routing for machines built before Oct.1, 1997.
 *B. Routing for machines built after Oct.1, 1997.

Note for storage: Before you disconnect monorail from front end, remove receiver from VELCRO® patch and remove cable from framelock area.

HOW TO WEAR YOUR POLAR™ (OR POLAR COMPATIBLE) HEART RATE MONITOR

1. WET THE ELECTRODES

Wet the electrodes (the two grooved rectangular areas on the underside of the Belt Transmitter) thoroughly with water or saliva.

2. SECURE THE BELT TRANSMITTER

Center the Belt Transmitter flat against your skin, as high under the Pectoral Muscles (breasts) as is comfortable. The Belt Transmitter should fit snugly and comfortably and allow for normal breathing.

3. ROW!!

Your heart rate will be displayed in the lower right display in all PM2 display modes.

NOTE: It sometimes takes a few minutes of exercise to achieve a consistent Heart Rate signal.

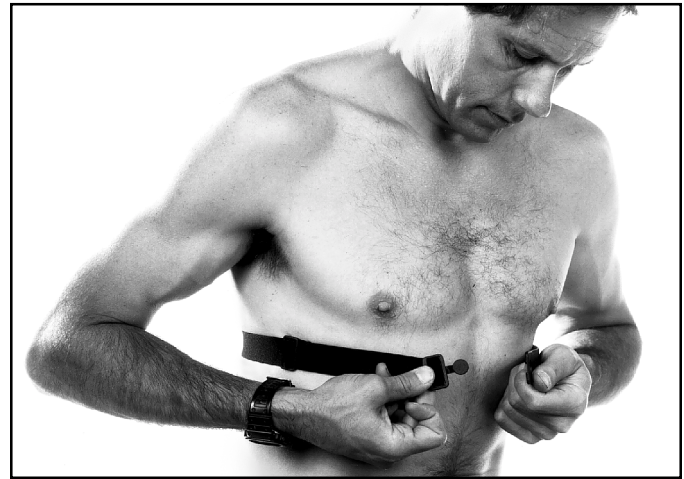

Read heart rate here.

Precautions

- Thoroughly wipe your Polar Belt Transmitter dry after each use.
- Do not store in a non-breathable or plastic bag where moisture may become trapped. Store in a warm dry place.
- Do not expose your HRM to direct sunlight, extreme heat above 50° Celsius (122° Fahrenheit) or extreme cold below -10° Celsius (14° Fahrenheit).
- Do not bend or stretch the electrode strips on your Belt Transmitter, especially when storing.

TROUBLESHOOTING

What if the heart rate reading is erratic or totally absent?

NOTE: Occasionally the Heart Rate Monitor will pick up bad data for a number of reasons. When the PM2 recognizes bad data, the display will go blank rather than show the bad data. It will take five seconds or longer to re-establish and display accurate readings.

1. Repeat the electrode wetting procedure as described above. The electrodes must be wet to pick up accurate heart rate readings.
2. Make sure the transmitter is centered with electrodes flat against your skin, as high under the pectoral muscles as is comfortable.
3. Wash your belt transmitter with mild soap and water, if you have not been doing so regularly.
4. Make sure your Receiver is within the proper range to receive transmission (1 meter/3 feet from your chest belt).
5. Check the connection on the back of the PM2 where the receiver cable plugs in. Check the connection between the cable and the receiver.
6. If you are exercising within range of strong electro-

magnetic signals the heart rate readings may elevate to abnormal levels. Common sources of electromagnetic signals are televisions, computers, cars, TV antennas, high voltage power lines and motor driven exercise equipment.

7. Signals from more than one Belt Transmitter within the transmission range (1 meter/3 feet) may also cause incorrect readings. Check your surroundings and move away from the source of interference if possible.

NOTE: Two Indoor Rowers with Heart Rate hardware must be at least four feet (1.22 meters) apart to avoid interference.

If further troubleshooting assistance is needed, call Concept2 at 1.800.245.5676.

MONITORING HEART RATE TO DETERMINE TRAINING INTENSITY

Medical authorities use the term “target zone” to describe the amount of physical activity which is enough to achieve fitness but not too much to exceed safe limits. This target zone is the level of activity which produces a heart rate of from 70-85% of the maximum attainable heart rate during all-out effort. (A rough formula for estimating your maximum heart rate is to subtract your age from 220.) Put in simple terms, your own heart rate can be used as a “speedometer” that tells you how much exercise your body needs for optimal physical fitness.

The following Target Range Chart, provided by Polar Electro, Inc., is based on averages and can only be used as a guideline. For more accurate information, consult your doctor.

NOTE: Before beginning any type of exercise program, consult your doctor if you are over 35 years of age, have not been following a regular exercise program, smoke, have high blood pressure or high cholesterol, or use a pacemaker.

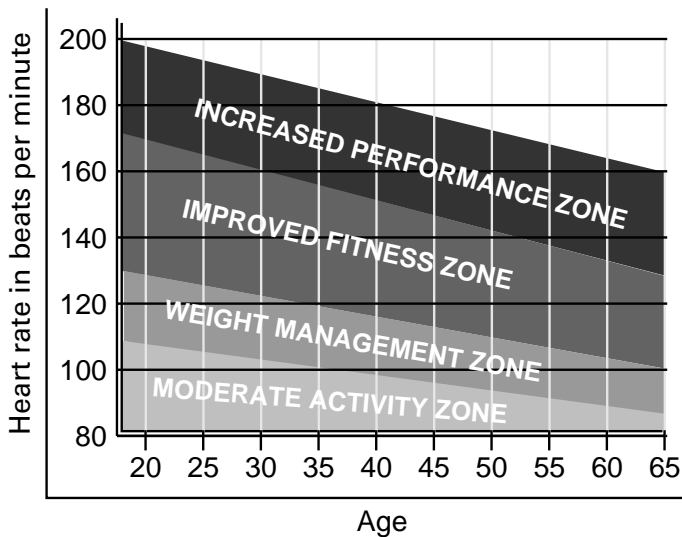

TARGET RANGE CHART

When you begin your exercise program, try to stay at the lower end of your target zone. As your fitness level improves, vary your exercise duration and intensity.

Choose your target zone according to your personal fitness goals. If your goal is weight management, high intensity, hard exercise is not necessary to burn fat effectively. (See the WEIGHT MANAGEMENT ZONE)

Exercising in the INCREASED PERFORMANCE ZONE (Above 85% of your maximum heart rate) is only necessary for competitive athletes.

EXERCISE DURATION AND FREQUENCY

Fitness experts advise that workouts should last approximately 30 to 40 minutes and be done at least three times a week. Your workouts should be spread throughout the week to let your body recover properly. Polar heart rate monitors guide you through your workout giving you continuous ECG-accurate heart rate readings.

TARGET ZONE EXERCISE PATTERN (40-year-old person)

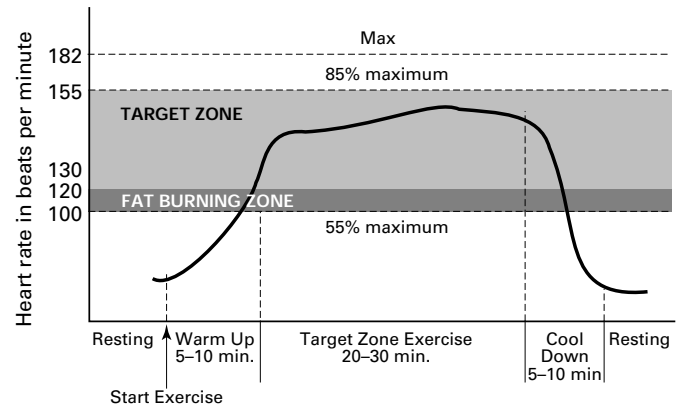

Begin each workout slowly and give your body a chance to warm up at least five minutes below your target zone. Gradually increase the intensity of your exercise until you are in your target zone. Remain in your target zone for 20 to 30 minutes. Gradually reduce the intensity of your exercise and let your heart rate fall below your target zone with a five minute cool down period.

DISCLAIMER

The material in this manual is for information purposes only. The product it describes is subject to change without notice. Neither Polar Electro Inc. or Polar Electro Oy makes any representations or warranties with respect to this manual or, except as stated in the warranty, with respect to the product described herein. In no event shall either Polar Electro Inc. or Polar Electro Oy be liable for any damages, direct or incidental, consequential or special, arising out of or related to the use of this manual or the products described herein.

Copyright © 1997 Polar Electro Inc.

CARE AND MAINTENANCE

NOTE: Any service done by a party other than Polar Electro Inc. or a Polar authorized service center during the warranty period voids the warranty.

The Belt Transmitter consists of an elastic chest belt and *integral molded transmitter* with electrodes which automatically activates when properly wetted and secured around your chest. The transmitter will shut off automatically when removed, however, sweat and moisture can keep the Belt Transmitter activated so it is important to wipe it dry after each use.

Clean the Belt Transmitter with mild soap and water regularly to remove any perspiration residue. Do not use abrasives or chemicals such as steel wool or alcohol in cleaning as they can cause permanent damage to the electrodes.

Belt Transmitter Battery: The estimated battery life is 2500 hours of use. When your Belt Transmitter Battery is depleted, contact Polar Electro Inc. or a Polar Electro Inc. authorized service center to obtain a replacement.

SERVICE

- Carefully pack your Receiver and Belt Transmitter in a shipping carton so that it is protected from shipping damage.
- Include a proof of purchase (a receipt or photocopy).
- Include a single sheet of paper stating why your HRM is being returned for repair. Print your name, address and daytime telephone number.
- During the warranty period the product will be repaired or replaced, at Polar's option, without charge by Polar Electro Inc. or a Polar Electro Inc. authorized service center. There is a charge to cover the return shipping and handling charge of warranty repairs (this is not a repair charge). Additional shipping charges are required for warranty repairs returned to destinations outside the United States.
- Ship postage prepaid to:
Polar Electro Inc.
370 Crossways Park Drive
Woodbury, NY 11797-2050
U.S Toll-Free: 1.800.227.1314
Canadian Toll-Free: 1.888.918.5043
- All HRM's are returned to the owner by regular UPS (Polar Electro Inc. will not ship to post office boxes). Priority shipping requests require additional fees.

LIMITED ONE YEAR WARRANTY

Non-commercial Applications

Polar Electro, Inc. warrants to the original consumer that the product will be free from defect in material or workmanship from the period of date of purchase indicated below:

- One piece (inclusive of battery)
waterproof Transmitter/Belt (PE40) ——— 2 years or 2500 hrs.
- Plug in Receiver ————— 1 year

Commercial Applications

Polar warrants to the original consumer that the products will be free from defect in material or workmanship for 90 days from the date of purchase.